Part XXII –Numbers Are Not What We Think

Author : Meiliken

Date : 25-06-2020

Our World is Inside Out

This is the most important post of them all. It not only ties them all together but will take us to another level entirely. Numbers are not what we think they are. We could not be more wrong. Our thinking has been far too limited.

There are complex and abstract numbers, but we are referring to even the simplest single digit numbers. Numbers make up and describe our entire world. If we are in a simulation, even a Divine one, they *are* our world. Some people like numbers, some are afraid of them. However, none of us actually understands them. We have been taught to view numbers in a passive sense, as a descriptive factor, such as 12 oranges doing nothing more than counting how many oranges are on the table. What if numbers played a more active role in our world. What if 12 was the motive or the operational factor and the oranges were just the objects to help us visualize the concept of 12. For anyone that has not been following this series from its inception, you can find the [entire work here](#).

Positive and Negative Space

The negative space in the Magical Cube of **42** was determined to be a volume of **22,005** cubic units. What specific cubic units they are is irrelevant, as the space is virtual and just a projection from a higher dimension where our units of measure are meaningless. That was based on the sum of the **27** Hebrew letter values, positive space, being **4995**, whose four digits sum to **27**, but which came first, positive or the complimentary negative space? Yet the numbers themselves are not meaningless. For example, for whatever reason the natural logarithm of **22,005**, or LN (**22005**), is **9.9990...** or precisely **1/1000** less than a perfect **10**. The value **1/1000** makes perfect sense to true Kabbalists and readers of this series given that the volume of this Magical Cube of **27** Letters operates in *Binah* hyperspace, a space based on the concept of **1000**, or **10³**, and thus the Essential Cube's total volume is (**27 x 1000**).

Have you ever asked why there are **10** Commandments; or **10** Plagues; **10** Patriarchs and Matriarch of collective value **2481**; **10** primordial component letters; or **10 sefirot** (dimensions)? Why **10**?

Abraham and Aaron

We know that the gematria of all 5 Book names in the Torah is **2480** and that of the two last Books, *Bamidbar* is **248** and *Devarim* is **256**, matching the names Abraham and Aaron, **248** and **256** respectively. We also know how both numbers connect to the E8 Lattice and how they connect in assorted ways throughout the (**248 x 42**) Torah matrix. What we have not discussed until now is that the natural logarithm of **12**, or LN (**12**), or put another way, $\text{Log}_e(12)$, is **2.48490665** and that the natural logarithm of **13**, the very next integer, or LN (**13**), or $\text{Log}_e(13)$, is **2.564949357**, with a difference of **.08004270** between them. This cannot be coincidental. Natural logs are not just another way to generate one number from another; they are used in exponential growth, similar to what we saw in the exponential curve of the *Alef-bet*. The two letters that correspond to the ordinal values **12** and **13** are *Lamed* (?) and *Mem* (?), whose combined numerical value is **70**, as in the **70** years of King David and all the other **70** year periods redundantly repeated throughout the Divine Calendar of history. Moreover, $(2 + 4 + 8) + (2 + 5 + 6) = 27$.

Maybe, we do not really understand what numbers are.

Spiritually, both Abraham and Aaron represent “love.” The Kabbalists have always told us that gematria and the numbers convey the deepest meanings of the Torah to us, the **70th** face of the Torah, and we have learned throughout this series that numbers can convey meanings to us no matter where we find them. Yet, those are still passive conveyances. Why are the numbers **248** and **256** next to each other Biblically and through the natural logarithms? What do the number **12** and **13** have to do with it?

The answer to those questions lies beyond our comprehension. We can only do simple computations like $(12 \times 13) = 156$, the numerical value of Joseph and Zion, and fit them in chronologically to the Divine Calendar, where we see that Joseph was born in **2200** HC, **252** (**6 x 42**) years after Abraham in **1948** HC, and **248** years before the Exodus from Egypt. Joseph passed away **55** (**2 x 27.5**) years before Aaron was born in **2365** HC.

It Always Goes Back to the Cube.

In the Magical Cube of **42**, there are **27** numbers from **1 – 27**, arranged in a very particular order, with the number **14** in the center. Each of the **27** numbers matches a different ordinal value for each of the **27** Hebrew letters, these total **378** for the **27** ordinal values and **4995** for the **27** actual letter values. Altogether, $(27 + 378 + 4995) = 5400$, which works out to (200×27) . Is this why there are **54** portions in the Torah? Or is this the reason: the sum of the digits in $(27 + 378 + 4995) = 54$?

In an equation, what comes first the solution or the components? What about in the higher dimensions? Must the digits sum up specifically before the components or answer is chosen? That cannot be done on our level; one should not have anything to do with the other. It is like saying 12 cherries and 12 apples = 24 oranges and by the way their volume is equal too.

72 Triplets

Do you recall early on in this series that the odd-even split of the *Alef-bet* was off from the Phi(?) split by a value of **54**, and that the sum of the square roots of the **72** Triplets as Triplets and letters was **1000.054**? Now we know why.

There are **27** sub-cubes within the Magic Cube of **42** and since each of those sub-cubes has **8** corners, there are a total of **216** corners within the Magic Cube of **42**, as in the **216** Letters in the **72** Triplets.

There are **27** sub-cubes within the Magic Cube of **42** and since each of those sub-cubes has **26** elements (8 corners, 12 edges, 6 faces) there are a total of **702** elements within the Magic Cube of **42**, as in the numerical value of Shabbat (**702**) that exists on a higher dimension and constitutes the **7th** millennium.

All numbers connect. It is a matter of untangling their web.

Untangling the Cube

Besides the **27** ordinal values, the total value of the **27** numbers is naturally also **378**, which works out to (14×27) , thus highlighting the central cube and central placement of the number **14**. All **3** components of $(27 + 378 + 4995) = 5400$ are each multiples of **27**.

The value **378** built into the equation is exactly **7%** of **5400**. It does not just work out that way; it was designed that way, and not by us. It was built into the Cube and the **27** letters of the *Alef-bet*.

The number **378** is the value of "*Echad Ushmo Echad (?????????????)*" or "His Name is One," whose final letters spell David (???) of numerical value 14.

The number **27** is exactly **.5%** of **5400**. It does not just work out that way; it was designed that way, and not by us. It was built into the Cube and the **27** letters of the *Alef-bet*.

3 Values; 3 Levels; 3 Dimensions

There are **3** tiers to this equation. The numbers and/or values **27**, **378**, **4995**, all are equivalent to each other in their own dimensions. All **3** numbers are expressions of the same concept. The number **27** exists in the realm of *Binah*; the number **378** exists in *Zeir Anpin*; and the number **4995** for the value of the same **27** Hebrew letters exists in *Malchut*. All **3** are "**27**" in the dimension of *Binah*. All are One (**1**) in the realm of *Chochma*. Therefore **27** is One(**1**).

No letter exists separately from the whole. No number exists separately from One(**1**).

We look at numbers as all existing in the same plane, linearly, much as we view time. This is extremely limiting and in the case of time, lethally limiting. The universe is not constricted by these limitations and is not linear. Geometry is non-Euclidean, and as we have seen, all these key numbers that keep coming up in every aspect of mathematics and throughout the structure of the Torah, and within the mathematical and physical constants themselves, all interconnect and intersect continually, fluidly. They even intersect with the key markers on the linear timeline that we have carved out.

The **27** Primordial forces or pressure mediations within the inertial fields are One (**1**) and undifferentiated in *Chochma*, the **9th** dimension. When they reach *malchut* they are represented by **4995**, but they are still **378** all together, and **27** individually and **1** as an undivided,

undifferentiated whole. Yet they never actually separated. They are all still altogether **5400** and all still One(1) at once.

This is a difficult concept to get our heads around, yet it is critical to escape the limitations and boundaries of this world. There is a relationship between the numbers in these different levels but that is not what connects them. A simple mathematical ratio between them would only reveal their relationship in the level of *Malchut*. What we call mathematics in the upper dimensions looks very different. For example, in our realm distance is measured in set, fixed units; in the upper dimensions distance is determined by similarity of form and is flexible.

Gematria, by revealing some of those similarities, helps us perceive the origins of the effects of the primal forces on our world. Detecting intersections and patterns between the numbers highlights those similarities and origins as well. Neither is meant to lead to a comprehension of the higher dimensions, but to the awakening that they exist. That awakening will lead to enlightenment.

A Place in Pi

The gematria of the word "Torah" is **611**, and the **611th** digit in Pi is **1**. It is immediately preceded by **...127...** The sum of all the digits in Pi through digit #**611** is **2700**. The numbers **1** and **27** have everything to do with the Torah, whose first verse has a numerical value of **2701**. Numbers are active operators in our world, not just passive markers. Most people have not even realized that numbers are even markers. There are numerous significant multi-dimensional sequences within Pi, as will be illustrated below. It should be kept in mind that when the sum of the digits through a specific sequence is significant on its own and/or through its interconnectivity it is telling us that every single digit (number) prior to it was purposely chosen to be there. The only way for that to have happened was at the moment of Creation.

By the way, the constants operate on the level of *Binah*, meaning that when we reach into them, we are tapping into the limitless Sea of *Binah*. While we can find notable sequences anywhere within the endless digits of Pi, we have only to look within the first **1000** as **1000** is the level of *Binah*.

Mod 9

Another pattern in this equation $(27 + 378 + 4995) = 5400$ is revealed by analyzing the sum of the integers in each number. This equation thus translates to $(9 + 18 + 27) = 9$. Another aspect of math is called modular arithmetic. It is a system of arithmetic for integers, where, like a clock numbers "wrap around" when reaching a certain value, called the modulus. In the case of a clock, it is mod 12. In the case of the above equation it is logical to apply mod **9**, where a number is equivalent to "0" whenever it wraps around to "9." Thus all the components in this equation are "0" in Mod **9** both in their original form and also in their secondary reduced form: $(0 + 0 + 0) \text{ mod } 9 = 0 \text{ mod } 9$.

By dividing both sides of $(9 + 18 + 27) = 9$ by **9**, the reduced (translated) equation transcribes to $(1 + 2 + 3) = 1$, illustrating how these **3** levels equal One(1).

This may also be incorporated into the first line of the **42**-Letter Name matrix (??????), which

begins with **1** and ends with **27**, and moreover begins **1,2,3,1** in small gematria, as in $(1 + 2 + 3) = 1$.

Understanding Why

The total ordinal value of the **27** Hebrew letters (**378**) in the above equation helped give us **5400**. The total value of the **27** numbers is naturally also **378**. If we add that **378** to **5400**, we get **5778**. Is this the reason that **5778** HC was the chosen year, and a span of **5778** years was the chosen time frame? Since the dawn of Creation, that year has always been written into Pi, Phi, base **10** mathematics, and the Torah, but is this the reason it was so indelibly engraved?

The year **5778** is part of a narrow cosmic window, a multi-millennial opportunity that for the most part is being wasted thanks to a clever opponent. Someone on the path to enlightenment would easily recognize the number **5778** as a marker, and specifically a marker in time. Someone more enlightened would realize **5778** was not just a marker, but the source code, a driving force unto itself. Someone actually enlightened would understand why. The realm of *Binah* translates to Understanding. Only at the level of *Binah* can we have true Understanding, everything else is a process to get there.

Given the relationship in the equation $(27 + 378 + 4995) = 5400$ to the number **9**, and that the sum of the digits in $(27 + 378 + 4995) = 54$, how interesting that the **3rd** of the triplet digit string **5778** in Pi is found at digit # **954**. To understand numbers, we must think multidimensionally. They do not exist in a vacuum and have little to no meaning statically. It is like a line of computer code: while it may be significant, without all the other lines of code it cannot do anything.

Since the equation $(27 + 378 + 4995) + 378 = 5778$ breaks down to $27(1 + 14 + 185 + 14) = (27 \times 214)$, we see that this Essential Cube of Creation equation at its core is **27** times the numerical value of *ruach* (???), **214**, spirit, as in the second verse of the Torah, "G-d's spirit moved on the water's surface." Not coincidentally, this verse has **14** words, as in $378/27 = 14$, which takes us to the center of the Cube(**14**), much like David (**14**) was at the center of the **5778**-year time span. The more we understand about a number the more we can interact with it. The more we interact with them the greater our connection to the upper dimensions. Rav Abulafia, of blessed memory, advised us that the highest understanding of the Torah was through the numbers. The number **5778**, whether on a calendar or on a license plate is meaningless without a conscious interaction. It is like having a cell number, you have to use it for it to mean anything. The Hebrew letters are just letters on paper without the primordial forces they connect too, likewise the numbers that help us interface with them.

When we now look at the number **5778**, we can now see the Spirit (???) of the Creator in it, like a soul in a body. As that Spirit (27×214) fills all the **27** sub cubes of a **3³** cube with **214** (???) in each, we can now picture the number **5778** as a specific cube. Indeed, we can picture it as the Essential Cube of Creation.

Accessing the Essential Cube of Creation

The Spirit (*ruach*) of the Creator is in the Cube, in **5778**. It breaches all **3** levels: *Malchut*, *Zeir Anpin*, and *Binah*. It is in every aspect of the Essential Cube of Creation. It makes the Cube,

One(1). And $1/5778 = .0001730\dots$, as in the small gematria of the **42**-Letter Name of G-d. Our understanding thus deepens, and our consciousness expands. We know how to use the **42**-Letter Name. It was the first gift of the Bible given to us. Since $5778 \times 1/5778 = 5778/5778 = \text{One}(1)$, we can see how connecting the **42**-Letter Name with the year (number) **5778** and the window of opportunity it brings us, can bring us closer to One(1) and the One. Moreover, we see how connecting the **42**-Letter Name with the year (number) **5778** can open up the power of the Essential Cube of Creation and help us access the Binah hyperspace.

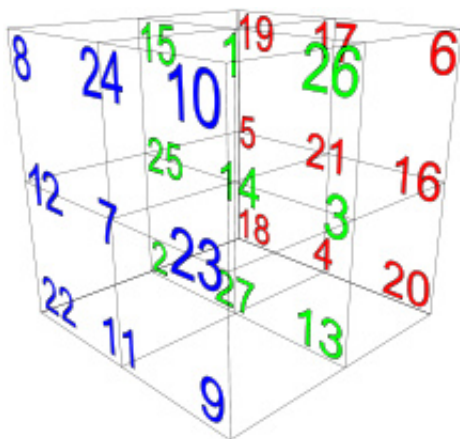

Rav Brandwein, of blessed memory, said that it is through the understanding of the **42**-Letter Name that we will bring about the *Geula* (final redemption). Remember, the Essential Cube of Creation is the Magical Cube of **42** since it was designed so that each of the **27** rows and columns would total **42**. Furthermore, because of this design, each of the **27** letters of the Hebrew *Alef-bet* are connected to the number **42** and the **42**-Letter Name. Perhaps this is why the Arizal, may his memory be for a blessing, said that no prayer elevates without the help of the **42**-Letter Name. This is our access to all points of the Essential Cube of Creation, our gateway to all points beyond.

The Square Root of Two

כהת	אכא	ללה	בוהש	עלם	סיט	ילי	והו
הקם	הרי	מבה	יול	ההע	לאו	אלך	הוי
זהו	מלה	י	זלך	פהל	לוו	כלי	לאו
ושר	לכב	אום	ר	שאה	ירת	האא	נתה
יז	רהע	זועם	אני	מנר	כוק	להוז	יזו
מיה	עשל	ערי	סאל	ילה	וול	מיכ	ההה
פוי	מבה	זית	ננא	עבם	הוזש	דני	והו
מוזי	ענו	יהה	ובמב	מצר	הרוז	ייל	נבם
מום	היי	יבמ	ראה	זובו	איע	מנק	דמב

Mathematics works different on different levels (dimensions). We have previously illustrated that taking the square root of the product of specific equations, like the values in the P/S cipher, yields its essence. That is how mathematics in our world can show us a glimpse of the higher nature of those numbers. In the level of *Zeir Anpin*, when we sum up specific numbers, take their square roots and sum those up, as with the two components of the **72** Triplets that worked out to **720.0** and **280.0** for a total of **1000.054**, we get an even higher glimpse into the source of

those numbers. We can apply that within the Essential Cube of Creation.

The Essential Cube of Creation is designed so that the value **14**, which as an ordinal number is at the level of *Zeir Anpin*, can be readily combined with every other letter in the Cube. Utilizing all **27** letters, that combination totals **378**, which works out to be (14×27) . When combined with the **27** Hebrew letters, which are on the level of *Malchut*, it adds **378**, and, as said previously, combined with the level of *Zeir Anpin* it also adds a total of **378**. The central (**14**) can combine with the level of *Malchut* as in the example of *Resh* (**200**) + **14** = **214**, *ruach* (???) . Or it can combine with the level of *Zeir Anpin*, as when it combines with itself: $(14 + 14) = 28$, as in *Koach* (??), power, and as in the **28** letters of the Torah's first verse that has the *Malchut* value **2701**, or $(27 + 1) = 28$.

When all **27** ordinal values of *Zeir Anpin* are combined with their corresponding *Zeir Anpin* (**14**) value, the total is $(378 + 378) = 756$, whose square root is **27.5**, the measure of the sacred cubit. When are the square roots of all **27** combined values (15, 16...41) are summed up, the result is **100** times the square root of two(2): **141.4227** or (100×1.414227) vs the precise square root of 2, **1.414214**, off by only 0.0000134275....

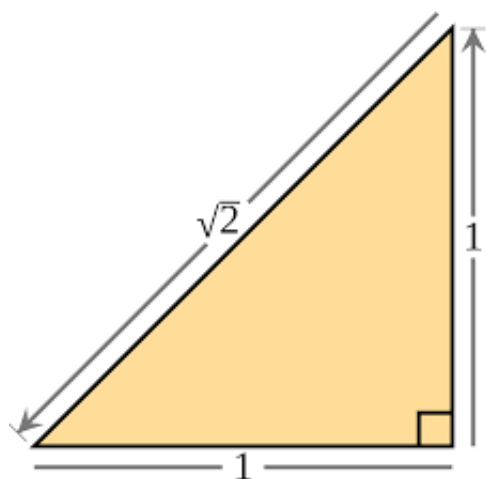

And we thought the square root of **2** was just a number used in geometry, notably with the squaring of circles. Only when we expand our consciousness can we see the connections, began to grasp the vastness and effect of multiple dimensions acting simultaneously. The *Zeir Anpin – Zeir Anpin* equations within the Cube above give us new connection points or portals (**?2** and **14**, **14**, **42**, and **27**), which are all also components of the equation, indicating a circling or self-referencing nature to the multi-dimensional system. The **?2** itself gives us **14**, **14**, **42**, and **214**, *ruach* (???) which we know is at the heart and essence of the Cube. Perhaps this is not so surprising since the **?2** represents the diagonal of any square of unit side length One(1) and thus of each of the **6** sides of a similar cube, or each of the 27 planes, but we did not use geometry to get to this value (**?2**). Mathematics works differently in the higher dimensions. Distance is measured by similarity of form. Their difference (0.0000134275....) gives us **13**, **42**, and **275** translated as *Echad/One*(1), **42**, and the sacred cubit again.

Without tracing the connections, numbers are just limitations. Without the right consciousness tracing the connections is limited. Without the desire for elevation, attaining the right consciousness is futile.

He and his Name are One

The concept of “He and his Name are One” is part and parcel incorporated into the negative and positive space within the Cube. As perceived in the higher dimensions the letters and the space that defines them are One and the same. Take a blank sheet of white paper. Every point on this sheet, no matter how small, holographically contains the whole paper. Now trace out the Name of G-d, any one of them. What do you see? The white inside the Name is the same as the white outside it. The name was there all along. By adding something (our ink), we think we have created something new, but in actuality we have taken something away, reduced or restricted the Light of the Creator. This is what happens with each level of metaphysical descent to our world. All the perceived existence around us, is just an extreme restriction of the light force of the Creator. This includes time and the linear line of death. The light-force must be reduced so many times (iterations)—as we illustrated long ago, **22** times per level—for multiple levels for us to perceive our own existence. As beautiful as our world is, we are but seeing shadows of shadows of projections of projections. Our world is so restrictive that we could be in a simulation and we would never know it. From the perspective of the Creator and the higher dimensions, it is all the same. A black sedan, a white coupe, a bicycle, no vehicle at all, life, death, all the same. Science will tell you the same. Cars, cows, life, death are all just 99.9999% empty space with a handful of pixie dust that we call quarks thrown in to interact with the fields of nothingness.

In the case of the Cube, the **22005** cubic units of emptiness (negative space) is exactly **.815** of **27,000**, or **81.5%**. We would have assumed that a perfect universe would have chosen **22,000** or (**22 x 1000**) to have worked out as a precise percentage of **27,000**, given the relationship between the **22** Hebrew letters and the **5** final ones to make **27** in total. Nevertheless, that would be our limitation again. Whose is to say that in the higher dimension of the negative space that 22,000 is the same as it is in our limited world. The Creator specifically chose **22,005** out of **27,000** to portray that positive/negative relationship, the same way He chose **2701** to represent the Torah’s first verse and not **2700**. In that specific case, He was illustrating to us that when a specific number equals the sum of all the integers through a particular number, like **73** in this case, representing the **9th sefira, Chochma**, then that chosen number (**2701**) is operating on a higher plane or dimension. What is this like? It is like the **90,100 Yuds(?)**, **Heis(?)**, and **Vavs(?)** in the Torah, given that **90,100** is the sum of the integers from 1 to **424**, **Moshiach Ben David**. Does this have anything to do with the nearest Star to our Sun being **4.24** Light years away? Probably, but it is not for us to find meaning in every connection, only to awaken to the reality that this universe was designed for us to awaken in.



Thus, we just learned another rule of higher dimensional mathematics. These rules do not show us what goes on mechanically in the higher dimensions; they just give us insights into them and insights in how to connect to them. Our goal, though, is not to unravel higher dimensional mathematics, but to expand our consciousness.

And just as $22005/27000 = .815$, a nice short round rational number, so too is $4995/27000 = .185$ a rational number, as is $4995/27 = 185$, from the equations above. The number $.185$ is equivalent to $1/(5.400 + .005400 + .000005400\dots)$, which means that the portion of the *Malchut* black fire letters to the whole ($4995/27000$) is equal to the One(1) divided by the whole(5400). Here is another example of higher dimensional mathematics at work, where we see the infinite echo of a number, like two mirrors facing one another. Again, these are representations of the numbers in the higher dimensions, not the mechanics of how the higher dimensions operate. In our world 5.400 and 5400 and .000005400 are light years away from one another and you would much prefer \$5400 in your wallet than \$5.40, but in the upper realms, they are virtually alike.

The ratio $22000/27000$ is not a rational number, and the next closest number to be rational is $21,978/27000$; there is logically only one every 27 numbers. Can we understand numbers without comprehending the principles with which they were created? The letters and their defining space ($4995 + 22005$) are One; $(4995 + 22005) = 1$.

That $(8 + 1 + 5) = (1 + 8 + 5) = 14$ is just yet another example of how little we understand the interrelation of numbers, and how key the central cube of 14 is to the Essential Equation.

$$1 - 14 - 27$$

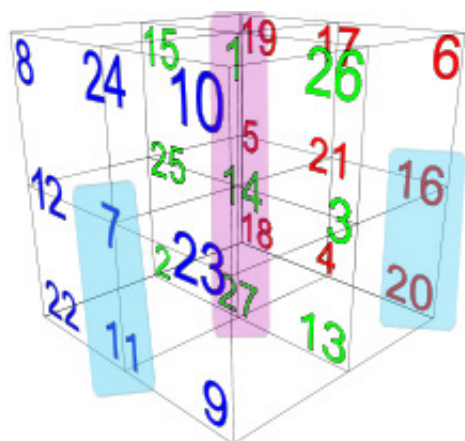

This relationship of $1 - 14 - 27$ found throughout our discussion today is very clearly portrayed in the design of the Magical Cube of 42 since it represents the $(1 - 14 - 27)$ central vertical axis of the Cube and, as such, naturally sums to 42 .

Also, within the cube we find two separate vertical pairs, the $7 - 11$ (??) pair that equals 27 , and the $20 - 16$ (??) pair that equals 270 . Together the $(7 - 11)$ and $(20 - 16)$ ordinal values = 54 , as in twice 27 and as in the 54 portions in the Torah. Why these were built into the Cube, we may never know.

That key $(1 - 14 - 27)$ central vertical axis of the Cube also enables the gift-wrapping function of the Magical Cube of 42 to work in that

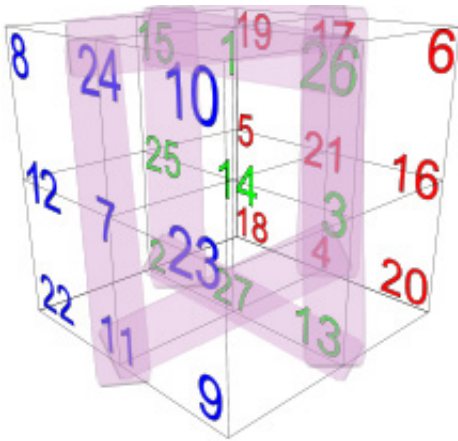

each strap of the bow tied around the cube necessarily equals **112**, as in the **112** Triplets that virtually orbit the Cube.

It should also be noted that the **112** Triplets contain **336** letters and $(336 + 42) = 378$ or (9×42) . This is not higher mathematics, just an illustration that so much more is at work here than we realize.

There is a rarely used and deeper gematria cipher that is extremely revealing. We have illustrated how it can be used multiple times already, including to derive Pi from the Torah's first verse. In this case, when we apply it to the key $(1 - 14 - 27)$ central vertical axis we get the Product of the components $(1 \times 14 \times 27)$ divided by the Sum of the components $(1 + 14 + 27)$ equals $P/S = 378/42 = 9$. Comprehension of the otherworldly nature of numbers is critical.

Furthermore, how is it, or why is it that $(1 - 27/42) = 5778/\text{Phi}(?)$?

$$1 - \frac{27}{42} \cong \frac{.5778}{\varphi}$$

Pi, Phi and 5778

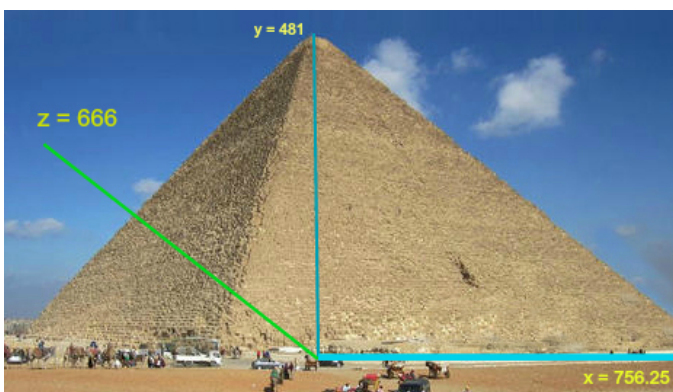

The two values **378** in the equation $(27 + 378 + 4995) + 378 = 5778$ together equal **756**, as in the total ordinal value, **756**, of the **6** faces of the Magical Cube of **42**; as in the base of the Pyramid (**756'**); and as in the spelled-out letter *Nun*(???), equivalent to the ordinal value **14** at

the center of the Cube. Not only is **756** equal to **(18 x 42)**, but $\text{Phi}(?)^{18} = 5778.000$. Perhaps this is the reason the base of the Pyramid is **756'** and its height is **5775"**. The intersections between the numbers and disparate items in our world are there to awaken our understanding. The numbers are meaningless unless we see the intersections and the entanglements, and these too are meaningless unless we see the multiple dimensions simultaneously at work. The sequence ...5778**18**57780... is found in Pi within the first **1000** digits and $\text{Phi}(?)^{18} = 5778.000$. Pi (3.1415926...) and Phi (1.6180339887...) have very definite and significant effects upon our world. They convert lines into circles and rectangles into spirals. Our existence is predicated on their existence. Yet they actually exist in the hyperspace sea of *Binah*. Why they intersect at this particular moment in hyperspace and how that translates into a window of time in our world is for us to fathom. As is also the role of the number **18**.

The Sacred Cubit

Was the relationship between **27** and One(1) the reason that the sacred cubit that the Pyramid and Holy Temples were based a on had to be **27.5** inches? Does it have to do with **27 being exactly .5% of 5400**? Does this hint as to what level /dimension/realm the designs came from?

We said **27** in our Essential Cube equation was from the realm of *Binah* and that $27 = \text{One}(1)$. The total of the equation, **5400**, represents that whole and thus One(1). Therefore $27/5400 = 1/1$ but one two different planes and so **27.5** equals **(1 + the reflection of 1)** or **1.111111...** on another level.

This may be why we found the recurrent progression formula fit the design of the sacred cubit and the Pyramid so perfectly.

$$\sum_{n=1}^{\infty} x + (-1)^{n+1} \left(\frac{x}{10^n} \right)$$

$$30 = \sum_{n=1}^{\infty} 27.5 + (-1)^{n+1} \left(\frac{27.5}{10^n} \right)$$

This fancy looking formula is a recurrent progression such that value **27.5** increases and decreases by an ever-smaller amount (**27.5 + 2.75 - .275 + .0275 - .00275 + .000275...**) until it eventual reaches **30.000000000000000000...** In other words, oscillating reflections of itself.

Moreover, **30** is the numerical value of *Lamed(?)*, the one letter associated with **42** through the **42** repetitions of the name Yehuda (?????) in the Torah and its complete value, which is **42**. It is also the one letter associated with the level of *Binah*, as it is the only letter designed to reach upwards.

And since **3** is essentially **30/10**, we also have:

$$3 = \sum_{n=1}^{\infty} \frac{27.5}{10} + (-1)^{n+1} \left(\frac{27.5}{10^n} \right)$$

Thus, we see that the **210**-cubit height of the pyramid, or **5775**” is purposely designed to be **3**” shy of **5778** in order to leave room for higher plane or *Binah* hyperspace cubit to complete it.

$$5778 = (210 \times 27.5) + \sum_{n=1}^{\infty} \frac{27.5}{10} + (-1)^{n+1} \left(\frac{27.5}{10^n} \right)$$

Phi and the Tower of Truth

And just to remind you, this applies to the Tower of Truth as well, which as we recall it structured based on the sum of the cubes from $1^3 - 20^3$, meaning as recently explained, it is operating on a higher level. And speaking of otherworldly connections, we have the **18** digit repeat sequence found in the Phi(?) based Fibonacci numbers derived by dividing every 4th Fibonacci number by **3** sequentially in mod **9**: **173557319826446289**. Astonishingly, the virtual **21st** cube in the Tower of Truth, associated with *Binah* through the Name *Ehyeh* (????) yields the equation whereby the **21st** cube’s volume, which is exactly **21%** of the **44,100** cubits³ Tower of Truth’s **20** cubes, divided by the total volume of all **21** stacked Cubes or $9261/(441,000 + 9261)$ cubits³ = exactly **.173553719826446289**.

The connection here obviously originates in the dimension of *Binah*. But why the swirling confluence with Phi(?), the Tower of Truth, and **18** once again?

The Essential Cube of Creation, the Torah, and the 42-Letter Name.

How about the Torah, whose first verse totals **2701**?

What is **1/27**? It works out to **.370370370370...**, which is **.3701 + .0002701 + .0000002701 + .0000000002701...** Yet another equation yielding an infinite reflective sum, this time combining two Essential Elements. The value of the **42**-Letter Name in our world (*Malchut*) is **3701** and that of the Torah’s first verse, which permutes into the **42**-Letter Name is **2701**. Their difference, **1000**, indicates they are together in the realm of *Binah* hyperspace, prior to their separation to create our existence. Now we see how they are connected and where, all through the Essential Cube of Creation.

The small gematria of the **42**-Letter Name in the level of *Zeir Anpin* is **173** or **(200 – 27)**, representing what the Zohar describes as the **173** keys to Heaven given to Moses. Connecting the numbers through the dimensional array we see that **1/5778 = .0017307026...** and **1/173 = .005780**

Notice that the $(200 - 27)$ connects with the (200×27) equation that represented the total for the Magic Cube equation of **5400**. The connections/interconnections are more important than the numbers themselves. You could have a cell number, but if there were not a satellite or a server to funnel that number through, what good would it do you? Here we see another element of the mathematics of the higher dimensions: the results of applying any of the operators (+, -, X, /) between the numbers are related. In this case **173** is related to **5400**.

Echad Ushmo Echad (?????????????)

In the level of *Binah*, the **42**-Letter Name is $1/27$. The Magic Cube of **42** is **27**. Together they are $27 \times 1/27 = \text{One}(1)$. "He and his Name are One."

The number **378**, the value of "*Echad Ushmo Echad (?????????????)*" or "His Name is One," is (9×42) . The value **378**, as the sum of the ordinal values, exists on the level of *Zeir Anpin*, and translates to **27** on the level of *Binah*. If on the level of *Binah*, the **42**-Letter Name is $1/27$ then on the level of *Binah*: *Echad Ushmo Echad (?????????????)*/ $42 = 27/27 = \text{One}(1)$.

The number **378**, the value of "*Echad Ushmo Echad (?????????????)*" or "His Name is One," is (9×42) . When the level of *Zeir Anpin* is combined with the level of *Binah*: *Echad Ushmo Echad (?????????????)*/ $27 = (9 \times 42)/27 = (1/3 \times 42) = 14$, the central cube.

The Power of 9

The number **378**, the value of "*Echad Ushmo Echad (?????????????)*" or "His Name is One," is (9×42) . On the level of *Zeir Anpin*: *Echad Ushmo Echad (?????????????)*/ $42 = (9 \times 42)/42 = 9$.

Twenty years ago, when I was first learning the secrets of the **42**-Letter Name, Rabbi Akiva, of blessed memory, told me the true secret was in the power of nine(9). I soon learned that nine(9) divided by the small gematria of the **42**-Letters was $9/1230490... = 73.141593...$ or **70** plus **Pi(3.141593)** with a precision accurate enough to get man to Mars, and it is also conveniently a reference to the **9th sefira, Chochma**, of numerical value **73**, but the secret was much deeper.

The two Echads(???) for One in "*Echad Ushmo Echad (?????????????)*" total **26**, as in G-d's Name *YHVH (????)*, which operates at the level of *Zeir Anpin*, **One(1)** less than **27**, which is at the level of *Binah*. As stated above, **378** is **27** in the realm of *Binah*, and **27** is $(100 - 73)$. The more you know, the more you grow.

The negative space within the Magical Cube of **42**, collectively is **22,005**. As we saw, the natural logarithm of **22,005**, or LN (**22005**) or $\text{Log}_e(22005)$, is $9.9990...$ or precisely $1/1000$ less than a perfect **10**, which exists in the level of *Chochma*, the **9th sefira** (dimension), hence we cannot even see it. It has no physical attributes. Another way of observing the above equation is $e^{9.9990} = 22,005$ with Euler's number (**e**) being equal to **2.718281828459045....** It too starts off with the equation $27 = \text{One}(1)$. We see across all borders the interconnectivity of numbers, both irrational and rational, both illogical and logical, both natural and impossible.

Even the numbers in the positive and complimentary negative space sum to **9**. The total **27,000** value reduces to $(2 + 7) = 9$. The components (**22,005** and **4995**) reduce to $(2 + 2 + 5) = 9$ and

$(4 + 9 + 9 + 5) = 27 = (3 \times 9)$. The total **27,000/9** is obviously **3000**, but the negative space portion $(22,005/9) = 2445$, the year Aaron turned **80, 3** years before the Exodus in **2448** HC and perhaps when the **10** plagues began. Moses was **77** at the time, which was **3333** years before **5778**. The positive space $(4995/9)$ is thus **555**, associated with the *Shechinah*. The ratio of $2445/555 = 4.40541$ with **44** being the numerical value of the 1st plague and the **541**, Israel, being the value of all the initials of the **10** plagues. We have been looking at numbers in this chapter as portals to the higher dimensions, but are numbers passive descriptors or are they active operators influencing time, placement and action?

Cycles of 7

Each face of the Magic Cube of **42** has a value of **126**. The **3** central axes have a value of **126** collectively. That is **7** sets of **126** that structurally create the Cube, as in the counting of time given to us in Genesis. The **6** surface days and **1** deeper day, split in **3** parts, that holds it all together, analogous to the **3** meals of Shabbat. Shabbat is the counter, the marker of time as we know it. Each Shabbat marks a cycle of **7** days, one week. Counting from the Creation of Adam, there are $(5779 \times 52) = 300508$ cycles of **7**. That is **358**, *Moshiach*, once the dots are connected.

At **5780** cycles of **52** annual cycles we have **300560** total cycles of **7**, which is numerically **4245** less than the **304,805** letters in the Torah. For those that think that maybe the Creator did not know about Man's counting of solar or sidereal years, **5778** sidereal years (**365.256** days) is **301492** weeks (cycles of **7**), as in the year **1492** when Columbus discovered America, whether revisionist hoodlums tear down his statues or not. The difference between counting cycles of **7** for **52** weeks every year for **5780** years and counting sidereal days for **5780** years, is **20** years. In other words, **2020** CE vs **2000** CE.

The Special Property of 9

Each of the **9** planes of the Cube, **3** along each of the **3** axes, have a collective value of **126**. The value **126** is (9×14) , anchoring them all in the central cube of **14**. Is it a higher dimension design element of the number **5778** that the central two digits sum to **14**?

And in thanks to the special property of **9**, whereby the digits in any number divisible by **9** sum to **9**: $(1 + 2 + 6) = 9$, and $(3 + 7 + 8) = 18$, and $(7 + 5 + 6) = 18$, and $(5 + 4) = 9$, and $(2 + 7) = 9$, and $(5 + 7 + 7 + 8) = 27$. But what gave **9** its special property?

We are at the cusp of understanding numbers. We are at the birth of enlightenment.

The numbers, the letters, the forces are One. The source is One.

And why is the bottom diagonal of the Cube $(9 - 27 - 18)$? Look how much Tesla accomplished.

Arrays and Expanding Space

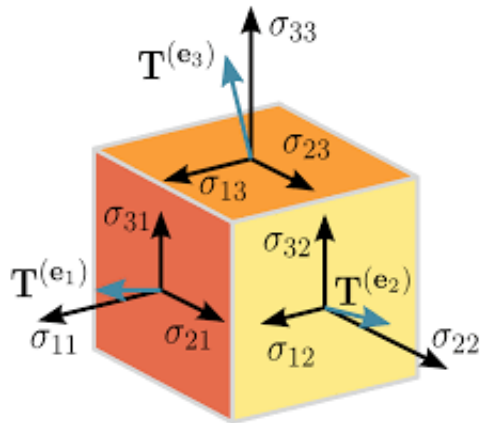

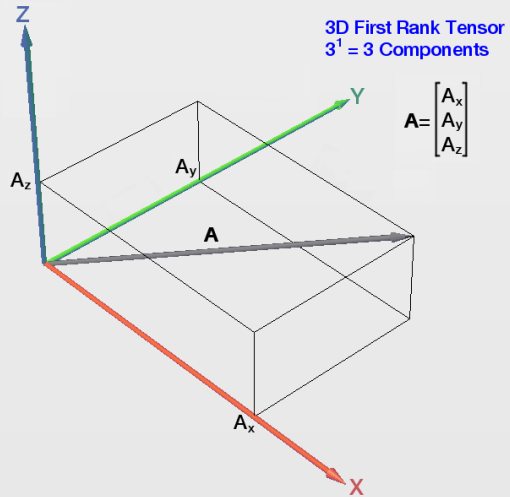
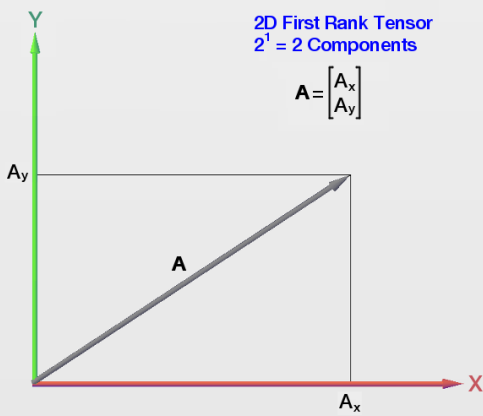

We think of the 3^3 Cube of **27** numbered sub-cubes as static, but mathematicians know that each one of the **3** directions of the cube can be stretched or “stressed” in **3** directions, making **9** in total, along the **9** planes of the Cube.

First Rank Tensors (Vectors):

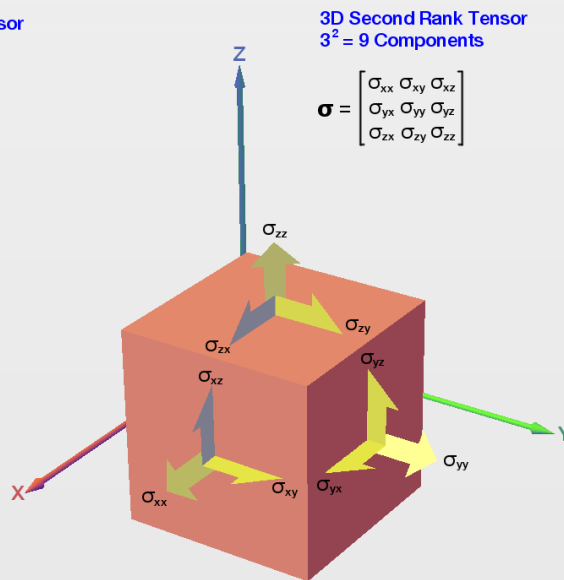
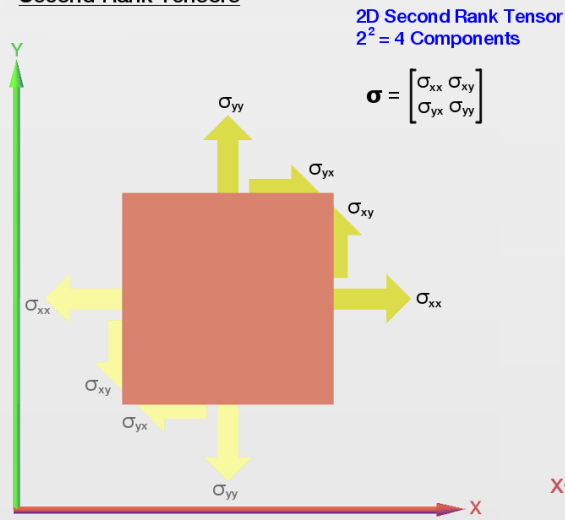

Second Rank Tensors



Rank 0:  (scalar)

Rank 1:  (vector)

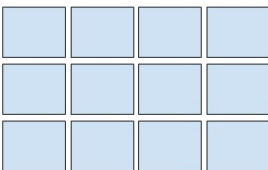
Rank 2: (matrix)

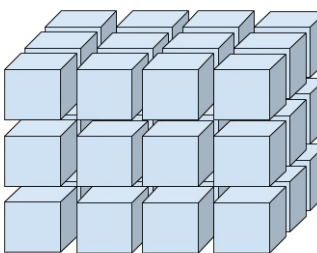
Rank 3:

tensor = multidimensional array

vector



$$\mathbf{v} \in \mathbb{R}^{64}$$

matrix

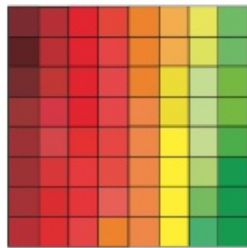

$$\mathbf{X} \in \mathbb{R}^{8 \times 8}$$

tensor



$$\mathbf{X} \in \mathbb{R}^{4 \times 4 \times 4}$$

This 3^3 cube is called a stress tensor, a Rank 3, 3 Dimensional stress tensor, also called a multi-dimensional array.

Rank 1 is a vector; Rank 2 is a matrix; and Rank 3 is an array. Each one of the sub-cubes has a coordinate placement (xyz) for each of the 3 axes from 1,1,1 to 3,3,3. If we add all 27 coordinates (111, 112, 121, 211...333) we get **5994**, and $(5994 - 4995) = 999$. If we did not know about the interconnectivity of numbers, we would say so what. If we did not know that the 27 Letters in the Magic Cube of 42 was a Rank 3 Dimension 3 stress tensor array that summed to 4995, and that $4995 = (5 \times 999)$, or that $27 = (9 + 9 + 9)$, or that natural logarithm of the negative space in that cube, $\text{Log}_e(22005)$, is **9.9990...**, we might say so what. If we did not realize that $5994 = (6 \times 999)$, as in the 6 directions and 6 bundled dimensions of *Zeir Anpin*, or that within the first 1000 digits of Pi there exists a numerical string of 6 9's, **...999999...**, and that the 6 9's sum to 54 we might say so what. If we did not further realize that that string of 6 9's "**...999999...**" means that the numerical string **...9999...** appears 3 times in those 1000 digits, matching up with the other two triplicate 4-digit strings, **...5778...** and **...2019...** we might have said so what? If we had not realized that the sequence **...999999...** was part of a larger sequence in Pi, **...999999837297804995...** and that **729** equals $(9 \times 9 \times 9)$ or 27^2 and that it is the value of the 2nd line of the 42-Letter Name Matrix, we may have said so what? If we had not seen that this 18-digit sequence **...999999837297804995...** connects the positive space (4995) with the negative space of the Magical Cube of 42 through $\text{Log}_e(22005)$, which is **9.9990**, we may have dismissed it. The same goes for noticing that the sum of the digits within the 18 digit sequence through the number 72 is 72. It goes the same for the 6 9's, **...999999...** that sum to 54, and the numerical string **...4995...** that sums to 27, effectively bookending the sequence with the numbers that define the Magical Cube of 42 on the level of *Binah*. And let us not forget the connection between the 72 Triplets and the number of their collective square roots, **1000.054**.

Since we did not miss any of it and since we know about the significance of connections between the numbers, we can understand one of the cosmic significances of our findings. When due to the counting methodologies previously discussed, the 2-year shift in the Hebrew calendar is taken into account and the 1-year shift in the Gregorian one is, we find that this **18** digit sequence is pointing us to the fact that the Magical Cube of **42**, the Essential Cube of Creation, would be revealed in the year **5780** HC (99999983729**780**4995) which is **2020** CE.

Since the triplicated 4-digit sequences of **9999** connects with **5778** and **2019** at the level of *Binah* the dating aspect in the **18**-digit sequence is further emphasized with the numerical string ...**5778**... found at digit #**954**, part of the fuller sequence ...5778**18**57780....

As mentioned in *The Divine Calendar*, the sum value of all the 947 digits in Pi up to the ...5778**18**57780... sequence is **4240**, the value of *Moshiach Ben David* x **10**.

And guess what number is found at digit #**995**, as in **4995**? It is **4**, and it begins the final sequence ...**420198**. Moreover, working backwards from the start of the final sequence ...**420198** at digit #**995** to the exact **4240**, *Moshiach Ben David* summery point where we found ...**57781857780**..., the sum of all those **48** digits is **210**, as in the height of the Pyramid in cubits and levels and in its **48** stories. It is also the **210**-year length of the Egyptian exile in years. Without connections numbers are just numbers, pixels painting the limitations of our world. We need to see the connections to begin to grasp their influence on our existence.

We began our discussion in this chapter with the values of Abraham and Aaron, **248** and **256** respectively. We asked why these numbers were back to back in the Torah and in natural logarithms. Since Abraham died in 2123 HC and Aaron was born in 2365 HC there is a difference of **242** years between their lives, matching the **242** years between the birth of America in **1776** CE and **2018** CE (**5778** HC). The Hebrew date for this momentous event was the **17th** of *Tammuz*, the **4th** month. The Western date was of course the **4th** of July, **1776**, matching the sequence in Pi at digit number **888**, ...**171776**..., which is additionally notable since **1776** is (2 x **888**). Nevertheless, since Abraham was born in **1948** HC and Aaron was born in **2365** HC there is a difference of **417** years between their births, matching the **17th** of *Tammuz*, the **4th** month, which is also the date the Second Holy Temple's walls were breached in **70** CE. Twenty-one (**21**) days later the Holy Temple itself would fall.

Gog V'Magog

Why is *Gog V'Magog* of numerical value **70** happening now in **2020**? Can it be the connection to the two *Shins* (??), of ordinal value **42**, which when spelled out *Shin-Shin* (???????) have a numerical value of **2020**. Each of the *Shins* (?) individually has the ordinal value of **21**, as in the Name *Ehyeh* (????) associated with *Binah*. The two *Shins* (??) would thus be associated with the magical powers in the Name "I Am That I Am (????????????????)," given to the Israelites in their darkest need in Egypt, as numerically it is (**21** – 501 – **21**) with an ordinal value (**21** – **42** – **21**). Life is all about timing. We understand that. It is more important to be at the right place at the right time or make the right investment at the right moment than being excessively smart or skilled. Being in the right place at the right time also means not being in the wrong place at the wrong time which can be devastating even if you have everything else in the world going for you. But what if numbers are not passive? What if they are active participants in our world? What if they create pressure mediations in our world, lives, timelines?

If you recall from much earlier in this series, there are four (4) forms of energy movement in our world. These are influenced by the 27 higher dimensions pressure mediations and the fields they interact with. These are four (4) forms, directly analogous to the YHWH (????):

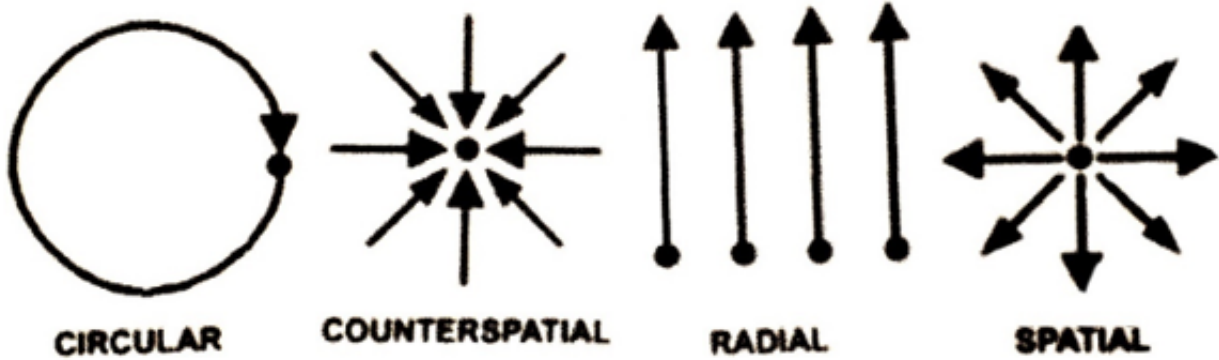

Now, let us flip their order, as if we were reading from right to left, as in Hebrew. Again, the order makes no difference as far, as we know:

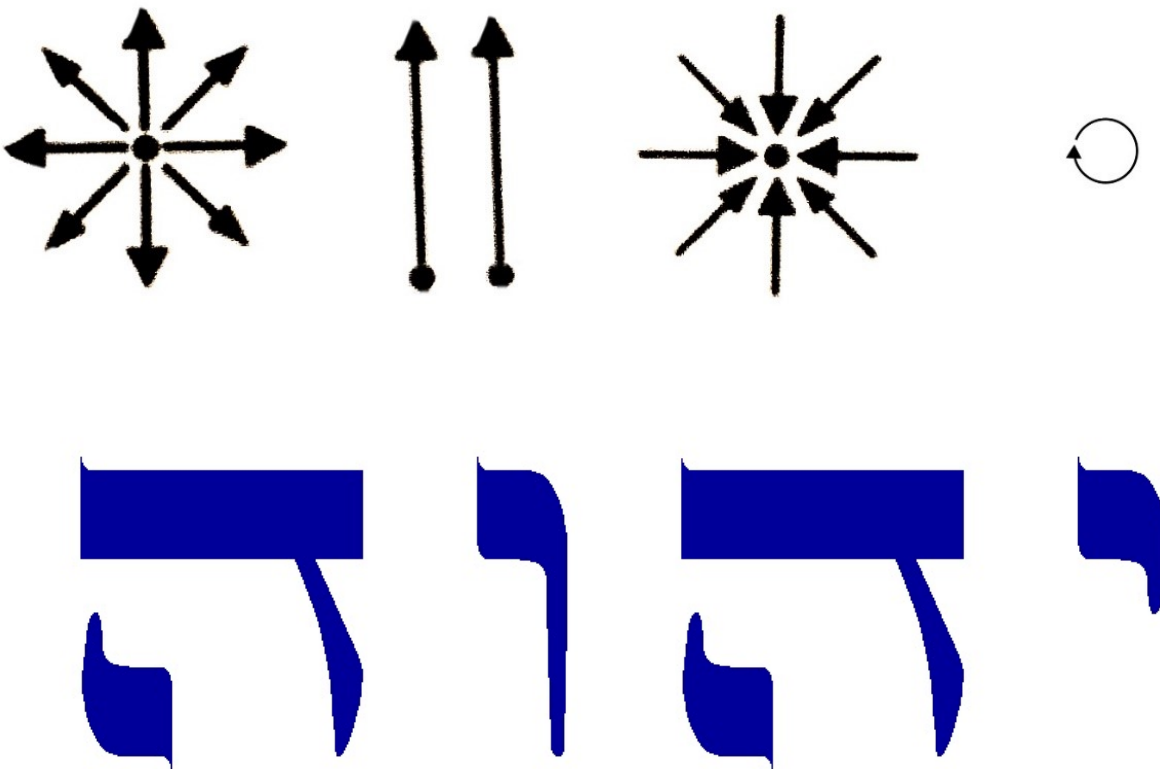

Here is another View of a Stress Tensor, to give you an idea what these energy movements look like in 3-d, our world as we perceive it:

Tensor of Rank 3: The Triad - A 3rd Look

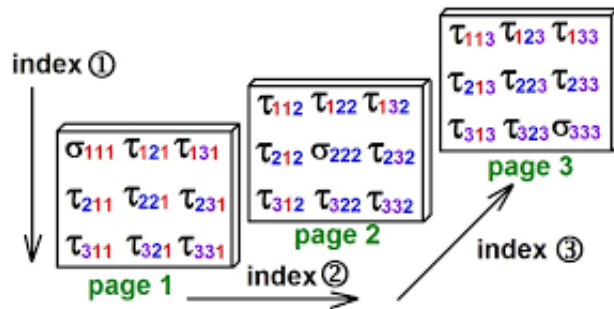

**Tensor of Rank 3:
The Triad**

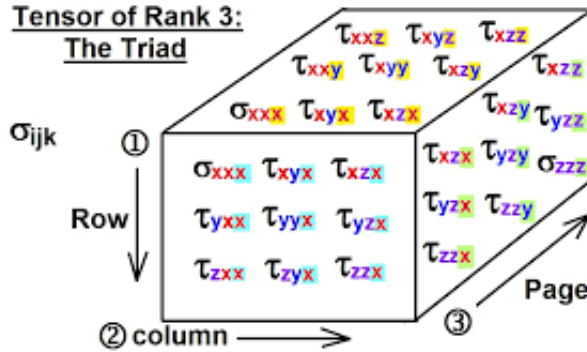

Here is the Stress Tensor, Rank 3, Dimension 3, depicting one of the pressure mediations, the Spatial one.

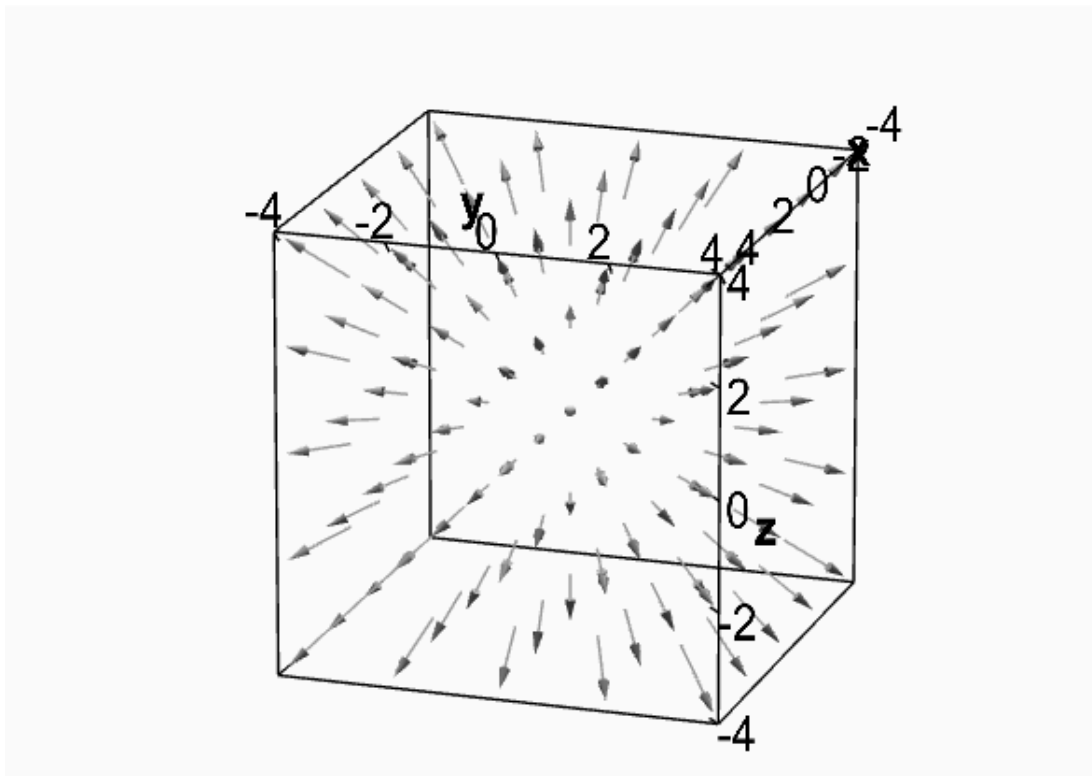

What if the same number could have different pressure mediations depending on what was happening in the upper dimensions? Like a magnetic that we see as repelling or attracting,

depending.

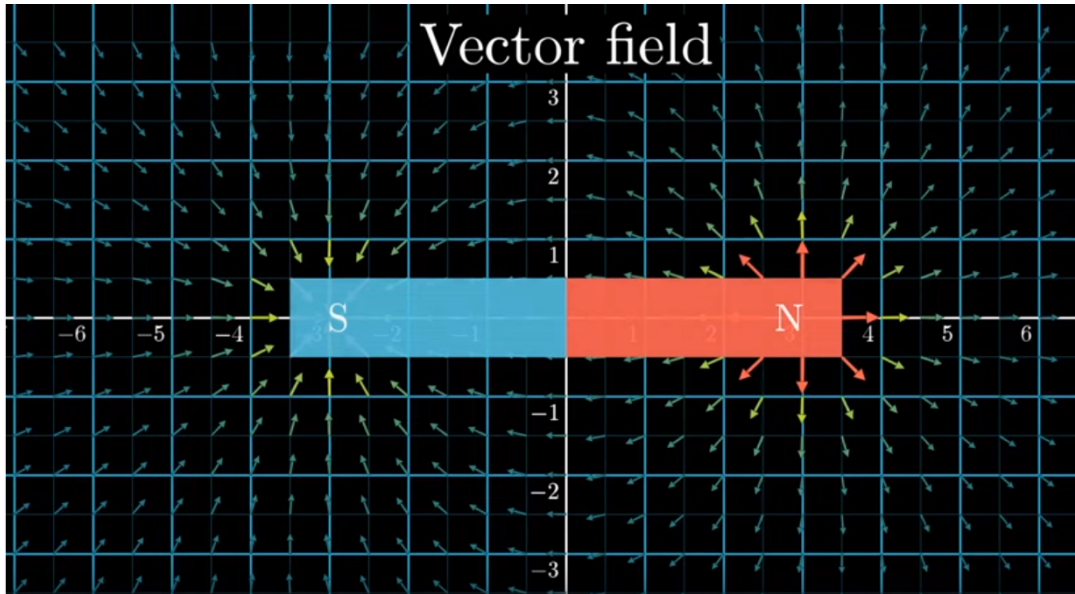

What if the same number could have different pressure mediations depending on who we are, or more accurately, our consciousness. A soul is a soul and not of this world, but a consciousness that wraps around that soul like the negative space that defines the positive space can be good or evil or usually an admixture of it. What if the same number could have different pressure mediations depending on our consciousness, attracting some, repelling others, actively sorting us out based on our intentions, spoken or otherwise. What if that number were a year or date on a timeline, sorting society into two camps?

How does a number decide? It does not. We do. Its qualities are programmed from the higher dimensions. In our world, likes attract, not opposites, as you have been told. Good attracts good, evil to evil, order to order, chaos to chaos. We see it with prominent people. Half the people hate Trump, half love him in spite of what 97% of the media and the Tech Titans tell them to think. It is inside us, or more specifically, wrapped around our soul. He has a number. Same with Obama.

Euler and the Sea of *Binah*

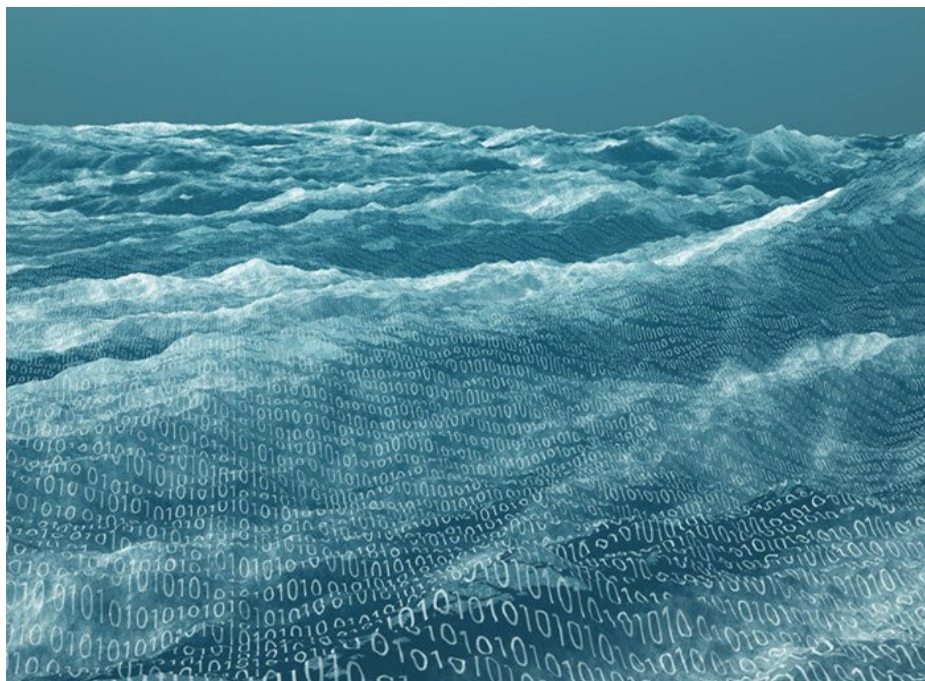

To most of us, seeing the first **16** digits Euler's Number, **2.718281828459045**... we immediately realize that something mechanical must be going on with these digits (**27, 18, 28, 18, 28, 45, 90, 45**), especially since we know the constants originate in the sea of *Binah*, as I once discussed with Rav Brandwein. That it begins with **27** must relate it to the Essential Cube of Creation, itself situated in *Binah*. Then **18**, which keeps coming up, even in the mysterious Phi(?) sequence associated with **21** and *Binah*, **.173553719826446289**, whose **18** repeating digits sum to **90**. Some look at **2.718** and say it is weird that it is only **.1** off of an abbreviated Phi(?), **1.6180**. Others say it is weird that $(2 + 7 + 1 + 8) = 18$ as in (**27, 18, 28, 18, 28, 45, 90, 45**) and $(2 + 7 + 1 + 8 + 2 + 8) = 28$ as in (**27, 18, 28, 18, 28, 45, 90, 45**), or that the pairs all sum as (**9, 9, 10, 9, 10, 9, 9, 9**) or **6 9's (999999)**. Where have we seen that before?

As we begin to learn the connections behind all things, we see that $(\text{Pi} - e)$ or **(3.1415926... - 2.7182818...)** = **.423310...** If you recall, the Adam and Eve ratio broke down to **19/45** or **42.22%** and **57.78%**, and the Tetragrammaton (????) ratio of *Chochma-Binah* to *Zeir Anpin-Malchut* (?? to ??) broke down to **15** and **11**, as in the **15** Triplets of the *Shema* and the **11** of *Bereshit*. This gave us a ratio of **11/26** and **15/26** or **.423** and **.577** respectively. This seems to be highly reminiscent of the result above, **.423310...**, which was based on Euler's Number, and also reminiscent of Euler's Constant (**.5772**). Nevertheless, the result of $(\text{Pi} - e)$ or **.423310825...** plus Euler's Constant (**.5772156649...**) equals **1.00052649**. Once again, we see the constants revealing themselves on the level of *Binah* (**1000**).

The 11 Dimensions and Pi

If you missed the connection between the number **11**, or the **11** dimensions of the *sefirot* including *Da'at*, and Pi and the **42**-Letter Name you are forgiven. Several times already we have illustrated the connection between the number **11** and aspects of the **42**-Letter Name, including how the value of the first line (?????) of the **42**-Letter Name Matrix, and also its last **4** letters (????) have a value of **506**, which is not only the complete value of *Moshiach Ben David*, but also the sum of the squares from $1^2 - 11^2$. And we just illustrated how **9/1.123049... = 73.141593... = 70** and Pi. What we never explained before was that Pi in Base **2** or binary, the

language of our computers, is **11.001...** and the sum value of the **42**-Letter Name, **3701/11.00100 = 336.424** or the **336** letters in the **112** Triplets and **424**, *Moshiach Ben David* in standard gematria. As for the **22,005** units of negative or complimentary space, **22005/11.001001 = 2000.273**, with the digital string **...2000...** also found in Pi at digit #601. The mathematics of at least **3** different dimensions are at play here at once.

The question is not How, it is Why. We cannot fathom “How,” but pondering “Why” leads to elevation.

The more you know, the more your consciousness expands. As previously explained, Pi is infinite, circles are infinite, and the Essential Cube of Creation expands (stresses) in **9** directions. There is no reason our consciousness cannot likewise expand. The more our consciousness shifts towards “good and order” the more the right numbers will be attracted to us and us them to further our expansion. Why order? Remember, there is nothing random in the universe. We can chose to see the order and the existence of the Creator in all things, or our consciousness can choose to see chaos like we have in our streets today. This is the meaning of the War of Gog U'Magog.

The most important connections are found in the least likely places. Numbers are not what we think they are.

We said previously that each of the **9** planes of the Cube, **3** along each of the **3** axes, have a collective value of **126**. There are two more less obvious planes in the Essential Cube of Creation, the diagonal planes across the Cube, making **11** planes in total, each with a collective value of **126**, or since each one is **14(10 – 1)**, collectively they are **14 (100 – 1)** in total. Why does each plane of the Essential Cube of Creation have to be **(3 x 42)**, and also **14(10 – 1)**? Do no ask How, ask Why. Why is it important that **9** be **(10 – 1)**?

A Question about a Prophecy

Most of us living today, could not miss the marker in Pi and in the equation above (**2000**) and associate it with time, as in the year **2000** CE. As for **273** in the result **2000.273** we recall that it is a number at the center of the dimensions of our solar system and the temperature of our universe and that it squares the circle, but in higher dimensional mathematics it is also **27³** and **(300 – 27)**. Moreover, **(2 x 7 x 3) = 42**, giving it a **P/S** ratio of **42/12** or **3.5**, also known as “Time times and half a time.” (Daniel 7:25 and Daniel 12:7) Why, not How.

A Question About the Pyramid

Since the base of the Pyramid, **756'** equals the **6** faces of the Cube (**6 x 126 = 756**), we should also ask why **(7 X 5 x 6) = 210**, the height of the Pyramid in cubits, or that the a **P/S** ratio of the Pyramid's height (**481.25'**) is **320/20 = 16**, or why together **(320/20** and **210/18)** their **P/S** ratios are **(16 + 11.666) = 27.666**, exactly **1/6th** more than the cubit itself **27.5**”?

Did **18** popping up again catch your attention, or did the denominators being **20** and **18**, or did the **16** as in the **16** digits of Euler's Number? Some pseudo-scientists will tell you that you only find what you focus on and that that is why you can make connections between numbers that others take for granted. What if the numbers are instead seeking you out? Or more accurately,

the higher dimensional forces behind the numbers. Nothing happens in a vacuum. In fact, there is no nothing.

A Secret to Redemption and the 42 Letter Name

Remember that special **18**-digit sequence within Pi ...**999999837297804995**... , well the digits in it that we had not highlighted (**8378**), not only include **378**, but are also a value of **22** less than **8400**, or (**8400 - 22**). Connections are everything. The gematria translation of **84** is *Pad*, redemption, and as Rav Brandwein, of blessed memory, explained to me, it is the fusion of the Upper and Lower **42**-Letter Names. As it so happens the natural log of **8400**, or $\text{Log}_e(8400)$, is **9.0359**, and on average, each of the **42** rows in the Torah, spanned across all **248** columns has a combined average total of **9300.59** words, letters, and verses. Keep in mind that the complete (*Zeir-Anpin-Malchut*) value of *ruach* (???) that permeates the Essential Cube of **42** is **248**. The Spirit of G-d spans across all **248** columns of the Torah Matrix. Meanwhile, $27^3 - 22^3 = 9035$. First there was the array, then there was the Essential Cube of Creation, then there was Matrix and then came the Torah to fill it.



To operate in hyperspace and break this down a little further, the number **8400** is (**42 x 200**), as in the equations (**200 - 27**) and (**200 x 27**) that



we just saw above with the **42**-Letter Name and the Magical Cube of **42** respectively. Moreover, the number **903** is the sum of all the integers from 1 – **42**, higher dimensional math at work. We also saw **903** in *Bereshit* (??????) when broken down to *Beresht* (?????) and *Yud* (?), or **903** and **10**; and again earlier as **903** times the square root of **5**, which is the core of Phi(?), that equals **2019.17**. Even earlier we realized that when using the same zig-zag method of climbing the **14** Triplets in the **42**-Letter Name that revealed Pi and Phi(?), we found the 2 column in the **11** Triplets of *Bereshit* total **903** and **1959** respectively, giving us **90359** as an extraction. The even much earlier, we saw **903** again as in **9** of the **10** Utterances in *Bereshit* that all begin with “G-d said, *Vayomer Elohim*” whose **10** Hebrew letters (????????????) total **903**. We now know higher dimensional math also reveals that so apropos simple equation that $(9 \times 3) = 27$, and $9^3 = 729$, the second line of the **42**-Letter Name Matrix, while the square of its P/S ($27/12$) is **5.0625**, the first line of the **42**-Letter Name Matrix and *H’Keter* (**625**), the square root of all the words, letters and verses in the Torah.

We can no longer look at numbers linearly.

We can now understand that the number **14** at the center of the Magical Cube of **42** has a deep connection to the **14** Triplets in the **42** Letter Name; as is the **3.14** in Pi; and the Archangel named Metatron of gematria value **314**; and the Name of G-d *Shaddai* (???)

I Am That I Am (?????????????)

If we take all 3 levels at once, the value 1 for *Alef*(?) becomes $(1 + 1 + 1)$; 2 for *Bet* (?) becomes $(2 + 2 + 2)$; 10 for *Yud*(?) becomes $(10 + 10 + 10) = 30$; 11 for *Caf*(?) becomes $(11 + 20 + 11) = 42$, making *Caf-Yud*(??) equivalent to **72**; then the central **14** for *Nun* (?) becomes $(14 + 50 + 14) = 78$ or (3×26) . Using higher dimensional mathematics again, reveals that the total of the **27** square roots of all **27** letter-number combinations is **314.278**. This is readily reminiscent of Pi, Metatron, and the Name of G-d, *Shaddai* (???) , all of numerical value **314**, and it is coupled

with **278**, the numerical value of “The gematria.” It is further reminiscent of **3142**, referencing the name “I Am That I Am (???????????????)” at Exodus **3:14**. We also saw **3142** in the simple equation dividing the total value of the **42**-Letter Name matrix by **506**, its first line, which is also the complete value of *Moshiach Ben David*, or $3701/506 = 7.31422$. We now understand that when utilizing the complete value of a letter, word, phrase, verse, etc. we are observing the combined or connected force of *Zeir Anpin* with *Malchut*. For example, while the ordinal (*Zeir Anpin* level) value of *Asher* (???) is **42**, the complete combined (*Zeir Anpin-Malchut*) value of each of the higher Names *Ehyeh* (????) is also **42**.

Here is a key to magical powers in the Name “I Am That I Am (?????????????????)” Beyond the triple **42**, we see that the sum of the **3** levels (*Binah-Zeir Anpin-Malchut*) of the Name are (**543 + 84 + 84**) = **711**, which is equal to the sum of all **22** ordinal values (**711**) of the entire *Alef-bet* spelled out, in other words, at full strength. This gives the Name “I Am That I Am (?????????????????)” mastery over the forces of the *Alef-bet* at the level (dimension) of *Zeir Anpin*, but only when all **3** levels of understanding are archived. And this is achieved through all **3** levels of the **42**-Letter Names.

Could this be related to the primal equation where we took all the prime numbers (**2, 3, 5, 7, 11, 13, 17, 19, 23...** as a string of digits (.**235711131719...**) and then divided One (**1**) by them to get the Primal Equation $1/.23571113... = 4.24248100...$ or **42** and **4248**, which is the sum of all **22** letters of the *Alef-bet* spelled out. Thus, the *Alef-bet*’s ordinal value (**711**) and its gematria value (**4248**) are interconnected through the prime numbers. Do we really have any understanding of numbers at all? Can we? Not if our consciousness remains on this limited plane.

Or the purpose of numbers? While we find *asher* (???) built into the first 4 letters of the Torah (????), we also find **3142** engraved, overlapping it, right into the first 7 letters of the Torah (????????) with small gematria (**2213142**). And using ordinal values, which we now know are on the level of *Zeir Anpin*, we have (**2 – 21**) built into the first 3 letters, illustrative of the **2** Names of value **21**, *Ehyeh* (????) in “I Am That I Am (?????????????????)”. The numerics, as we just saw with the primes and see repeatedly with Pi, whereby the numbers convey cryptographic messages, operate on the level of *Binah*. In the case of the ordinal values within *Bereshit*, these too give us (**2 – 21**). And the ordinal values within *Bereshit* (????????) can also break down sequentially to **22** and **54**, while the total **76** is the natural log of **2000** or LN (**2000**) = **7.600...** This gives whole new meaning to “In the Beginning G-d Created.”

There was G-d, then He Created the Beginning, then there was “In the beginning G-d created.” This changes the meaning to existence.

????

The real kabbalists knew that each level of expansion took them one level of understanding higher into the *sefirot*. They were looking at *Zeir Anpin* and then *Binah* with each expansion so we can now understand why the two most powerful Names, *Ehyeh* (????) and the Tetragrammaton (????), when expanded into **3** dimensions (iterations) together also equal **3142**.

????

the actual *Shema* that have the initial letter *Alef* (?).

One last parting gift, the complete (*Zeir Anpin-Malchut*) value of *Moshiach*(????) is **410**, the same as *Shema*(???). When you recite the *Shema*, how many levels can you now consciously connect to? The same can be asked when you recite the **42**-Letter Name? How do we elevate?

Like the **18** digits in the special sequence within Pi ...**999999837297804995**... and the **18** in the ...**57781857780**...sequence and in the equation $\text{Phi}(\text{?})^{18} = 5778.000$, there are a total of **18** planes within the Essential Cube (**9** horizontal/vertical and **9** diagonal ones), each equal to **126** for a total of (**54 x 42**).

How much true beauty awaits us once the numbers that surround us are connected through the hierarchy of dimensions.

For anyone that has not been following this series from its inception, you can find the [entire work here](#).